

HXI

Closed circuit cooling towers



Key benefits

- No plume
- Superb water savings
- Cost saving

HXI characteristics

Combined flow, axial fan, induced draft
Hybrid wet-dry cooling

Capacity range

up to 1290 kW

Maximum entering fluid temperature

82°C

Typical applications

- Medium to large HVAC and industrial applications
- Water saving requirements
- Plume reduction requirements



No plume

- **Non-plume** wet operation thanks to [dry finned coil](#): it reduces humidity of discharge air from the prime surface coil.

Superb water saving

- Patented intelligent **flow control system!**
With a [3-way valve](#) for precise setting of outlet fluid temperature and unrivalled annual water-saving.
- Load profile-adaptable to **dry, adiabatic** or combined **wet-dry** operation.

Cost-saving

- [Evaporative cooling](#) PLUS unique [combined heat transfer system](#) for minimized system-wide energy consumption.
- **Axial fan** – half the consumption of rivals and huge single cell capacity: saving you more!
- Less water usage = less water costs = **less water treatment expenses**

Low maintenance and easy inspection

- **Inspect and maintain safely** HXI towers with unrivalled comfort, while **standing** inside.
- The HXI has a **spacious plenum** (internal area) and easy inspection/maintenance access.
- **Access via large hinged door to internal walkway**: no basin draining needed for unit interior inspection.
- Easy to inspect the **coil** during operation from the outside or from the inside via the **removable drift eliminator modules**.
- Easy to inspect the **fill** from the inside and via the **removable combined inlet shields** from the outside.
- The patented [Bacross fill](#) sheets reduce fouling, allowing an easy inspection of the fill core without dismantling. Optional [BACross fill bundles](#) for quick and easy removal and cleaning of the fill.
- Self-cleaning cold water basin and fill above **sloped basin** to flush out dirt and debris.
- Removable **suction strainer** anti-vortex hood.
- Make-up, drain and overflow easily **accessible from the outside** for inspection and cleaning.

Flexible operation

- **Multiple fan motor system** covers independent fan motor and drive assembly per fan with a plenum partition for independent fan operation. For extra capacity control or stand-by fan in case of fan failure.
- Various **corrosion-resistant materials**, including the unique [Baltibond hybrid coating](#) for guaranteed long service life.
- **Single-side air inlet and discharge**, fits in most enclosures.
- **Unique and patented heat transfer system**: featuring [combined flow](#) via heat exchange coil and fill



pack, for fine temperature applications and thermal challenges.

- Patented **intelligent flow control** system!

Maximum operational safety

- Easy-clean and easy-inspect HXI units **reduce hygiene risks** from bacteria or biofilm inside.
- **Combined inlet shields** block sunlight to prevent biological growth in the tower, filter the air and stop water splashing outside.
- The patented [BACross fill](#) reduces fouling.
- The **drift eliminators** certified by Eurovent, to prevent droplets escaping into the air.

Interested in the HXI hybrid closed circuit cooling tower for cooling your process fluid? Contact your local [BAC representative](#) for more information.

Downloads

- [HXI hybrid closed circuit cooling tower](#)
- [HXI hybrid closed circuit cooling tower \(brochure\)](#)
- [Operating and Maintenance HXI](#)
- [Rigging and Installation HXI](#)
- [Combined Flow Technology](#)

Principle of operation

Closed circuit cooling towers

Principle of operation

Water saver mode

The spray water **pump (1)** is turned off and the **modulating flow control valve (3-way valve) (2)** remains fully open. The warm process **fluid (3)** flows both through the **finned discharge coil (4)** and the **prime surface coil (5)**.

An **axial fan (6)** draws the ambient **air (7)** over the coil and the heat is rejected from the fluid inside the coil. In this mode neither water consumption nor plume occurs.

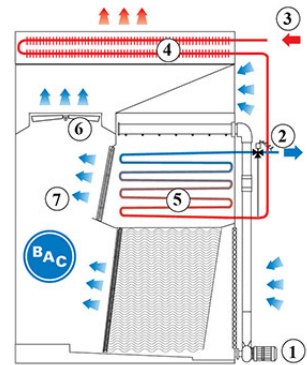

Adiabatic mode

The **flow control valve** (3-way valve) (1) lets the warm process **fluid** (2) flow through the **finned discharge coil** (3), by-passing the **wet prime surface coil** (4). The prime surface coil and the **fill pack** (5) are wetted by the **spray water** (6) but there is no water evaporation for heat rejection purposes. Some water will however evaporate. This will humidify the incoming ambient **air** (7) that is blown over the finned discharge coil by an **axial fan** (8). This saturated **air** (9) has a better cooling capacity to cool down the process fluid in the finned coil. The spray water drops into a sloping basin or **sump** (10). A pump recirculates the water to the spray system. Visible plume and water consumption are greatly reduced while the design fluid outlet temperature is kept.

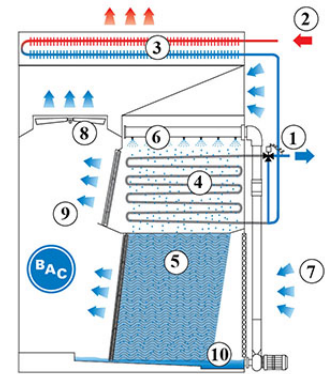

Energy saver mode

The warm process **fluid (1)** flows both through the **finned discharge coil (2)** and the **prime surface coil (3)**. An **axial fan (4)** draws the **air (5)** over both coils and **fill pack (6)**. At the top where the warm fluid enters the tower, the discharge **air (7)** is saturated and pre-cools already the fluid. Then a next heat transfer process occurs in the prime surface coil which is wetted by the **spray system (8)**. The cooled fluid **exits (9)** the tower. The spray water flows further over a fill pack, improving the heat transfer process by sub-cooling the spray water. The water is collected in a **sloping basin (10)** and a **pump (11)** recirculates the cooled water again over the prime surface coil. When there is less heat load or the ambient temperature drops, the **modulating valve (12)** will control the flow through the prime surface coil in a way that the design fluid outlet temperature is kept and water is saved. Plume is also minimized because there is less evaporated water and the discharge air is heated with the dry finned coil.

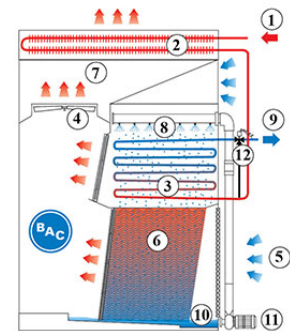

Want to use the HXI hybrid cooling tower to cool your process fluid? Contact your local [BAC representative](#) for more information.

Downloads

- [Combined Flow Technology](#)



Construction details

Closed circuit cooling towers

Construction details

1. Material options

- Heavy-gauge hot-dip galvanized steel is used for external unit steel panels and structural elements featuring [Baltiplus Corrosion Protection](#).
- The unique [Baltibond hybrid coating](#) is an optional extra. A hybrid polymer coating for longer service life, applied pre-assembly to all hot-dip galvanized steel components of the unit.
- [Optional stainless steel](#) panels and structural elements of type 304L or 316L for extreme applications.
- Or the economical alternative: a **water-contact stainless steel cold water basin**. Its key components and the basin itself are stainless steel. The rest is protected with the Baltibond hybrid coating.

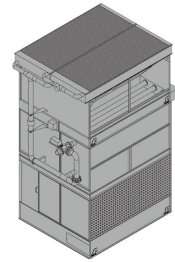

2. Heat transfer media

Unique and patented heat transfer system: **featuring combined flow** via heat exchange coils and fill pack.

Prime surface coil

- **The prime surface coil** is constructed of continuous length of prime surface steel, hot-dip galvanized after fabrication. Designed for free drainage of the fluid and for maximum 10 bar operating pressure according to PED. Pneumatically tested at 15 bar.
- All hot dip galvanized and stainless steel coils are delivered with BAC's **Internal Coil Corrosion Protection**, to ensure an optimal internal corrosion protection and guaranteed quality.
- Try our coil option: **stainless steel coil** in type 304L or 316L.



Finned coil

The **dry finned coil** is constructed of copper tubes with rippled edge and aluminium flat plate fins. Designed for free drainage of the fluid and for maximum 10 bar operating pressure according to PED. Pneumatically tested at 15 bar.

Fill

- The patented and factory-tested [BACross fill](#) with integrated **drift eliminators**. Optional [BACross fill bundles](#) with handles for quick and easy removal and cleaning of the fill. The bundle includes individual **sheets** which are easy to dismantle for inspection and cleaning, eliminating the need for frequent fill replacement.
- In self-extinguishing **plastic**, which will not rot, decay or decompose.
- For operation above 50°C, try our **optional high temperature fill**, usable with spray water up to 55°C.

3. Air movement system

- **HXI fan system** features two corrosion resistant sheaves, belt and motor. Together with the heavy duty fan shaft bearings and the BAC **Impervix** motor, this guarantees optimal and year-round operational efficiency.
- **Low kW and noise axial fan(s)** in corrosion resistant aluminum, encased in fan cylinder.
- **Option: flow control package** includes a [3-way valve](#) with actuator and connecting piping
- Our **drift eliminators** in the coil section come in UV-resistant plastic, which will not rot, decay or decompose and their performance is tested and **certified by Eurovent**. They are assembled in **easily handled and removable sections**, for optimal coil access.
- Easy removable UV-resistant plastic **combined inlet shields** at air inlet. Sunlight block to prevent biological growth in tower, air filter and water splash-out stop.

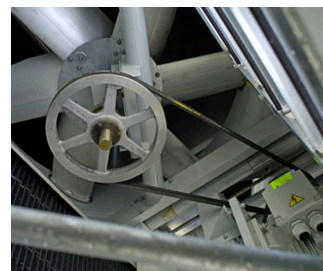

4. Water distribution system

These consist of:

- **Spray branches** with wide non-clog, plastic, 360° distribution nozzles secured in grommets. Overlapping spray pattern for complete coil wetting.
- A **sloped cold water basin** with: large hinged and inward swinging **access door** and **internal walkway** .
- Anti-vortexing **strainers** and **make up** both easily accessible from air inlet side.
- Close coupled, bronze fitted centrifugal **spray pump** with totally enclosed fan cooled (TEFC) motor. Bleed line with metering valve installed from pump discharge to overflow.



Need more information? Contact your local [BAC representative](#).



Options and accessories

Closed circuit cooling towers

Options and accessories

Below is a listing of the main HXI options and accessories. If your required option or accessory is not listed, look no further than your [local BAC representative](#).



BACross bundles

For even easier **dismantling and cleaning** of the BACross fill sheets, choose fill bundles with support handles.



Sound attenuation

Reducing noise at air **intake and discharge points** brings us closer to silent cooling equipment.



Plume abatement coil

A finned discharge coil is installed in your cooling tower discharge and piped in series with the wet coil. This **reduces or eliminates plumes** and **extends the dry cooling capacity**.



3-way-valve

A 3-way-valve is installed on your cooling tower in order to assure maximum water savings.



Remote sump connection

The best way to **prevent a sump freezing** is to use the auxiliary remote variety within a heated area. Shutting off the circulating pump allows all the water in the water distribution, as well as that in suspension and the sump to drain freely to the auxiliary sump.



Basin heater package

Thanks to our factory-installed heaters, the water stays at 4°C and **never freezes**, even during equipments downtime and however cold it gets outside.



Electric water level control package

For perfectly precise water level control, replace the standard mechanical valve with our electrical water level controller.



Platforms

To inspect and maintain from the top of the unit more **easily** and **safely**, platforms can be installed.



Internal service platform

An internal platform helping you **access the unit top inside** and safely inspect your cooling towers.



Extended lubrication lines

Extended lubrication lines with easily accessible grease fittings can be used **to lubricate** fan shaft bearings.



Safety switch

Cuts power to motors **with safety in mind** during inspection or maintenance.



Standby pump

Install a standby **reserve spray pump** as failure backup!



Vibration cut out switch

When excessive vibration occurs, this switch shuts down the fan, ensuring your cooling equipment **operates safely**.



Water treatment equipment

Devices to control water treatment are needed to ensure proper **cooling tower water care**. Not only does this help protect the components and fill pack, controlling corrosion, scaling and fouling, it also avoids the proliferation of harmful bacteria, including **legionella**, in the recirculating water.



Filter

Separators and media filters efficiently **remove suspended solids** in the recirculating water, reducing system cleaning costs and optimizing water treatment results. Filtration helps you keep the recirculating water clean.



Sump sweeper piping

Sump sweeper piping **prevents sediment collecting in the cold water basin** of the unit. A complete piping system, including nozzles, is installed in the basin of the tower **for connection to side stream filtration** equipment.

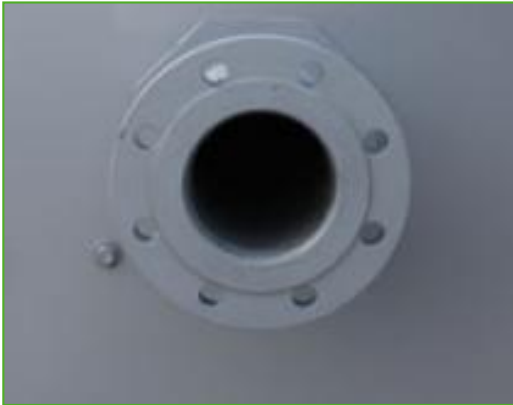

Flanges

Flanges facilitate **pipng connections** on-site.



Special needs?

Closed circuit cooling towers

Special needs?

Our ongoing [R&D](#) investment helps BAC offer you a complete set of solutions **for HXI hybrid closed circuit cooling towers that meet your needs**. Plus, we also cater for extra requirements such as:

Sound control

HXI uses a centrifugal fan in a V-design enclosure for better sound-control.

A quieter tower rear for more noise-sensitive areas.

Helping keep it near noiseless with [sound attenuators](#).

Plume control

Tap into abundant BAC plume control experience. For the HXI line, we offer [plume abatement coils](#) with **reduced plume** and an optional 3-way valve for **intelligent flow control**.

Check out our [BAC plume visualization software](#) for insight into **how your cooling equipment will plume** before installation. Helping you choose the best and most effective plume abatement solution.

Water savings

You need water for evaporative cooling. At BAC, however, we offer acclaimed and advanced water saving technologies. Helping in this aim are:

- [Electric water level control package](#)
- [Water treatment equipment](#)
- [Sump sweeper piping](#)
- [3-way valve control](#)
- [Plume abatement coil](#)



Energy saving

HXI uses evaporative cooling technology for lower operating temperatures than other cooling methods. With the following options, reduce energy costs still further:

- Thermostat

Enhanced hygiene and water care

Water circulates in evaporative cooling towers and it is important to avoid excessive accumulation of dissolved solids. The following options help keep your cooling tower clean:

- [Remote sump connection](#)
- [Water treatment equipment](#)
- [Sump sweeper piping](#)
- [Filters](#)

To control biological growth and scale formation, the water quality of the circulated water should be checked regularly. [Water quality guidelines](#) can be found in the [Knowledge center](#) of the website.



Year-round reliable operation

Inspect and maintain your cooling tower and protect it against extreme weather for year-round reliability. The options below help keep your cooling tower running smoothly and reliably and facilitate maintenance.

- [Remote sump connection](#)
- [Water treatment equipment](#)
- [Sump sweeper piping](#)
- [Filters](#)
- [Electric water level control package](#)
- [Basin heater package](#)
- [Standby pump](#)
- [Extended lubrication lines](#)
- [Internal platform](#)
- [External platform](#)

Do you too want to benefit from the above solutions? Contact your [local BAC representative](#) for more information.

HXI 42X-44X

Closed circuit cooling towers

Engineering data

REMARK: Do not use for construction. Refer to factory certified dimensions & weights. This page includes data current at time of publication, which should be reconfirmed at the time of purchase. In the interest of product improvement, specifications, weights and dimensions are subject to change without notice.

General notes

1. Pipe sizes are nominal diameters. All connections have BSP male thread except for the 15 mm vent which has a female BSP thread.
2. Dimensional drawings show standard (right hand) arrangements with the standard finned coil arrangement. Left hand arrangement can be furnished by special order.
3. Coil connection locations are approximate. Dimensions should not be used for prefabrication of the connecting piping.
4. For high process flows, the double serpentine finned coil arrangement (HXI D) might be used. For a finned coil bundle with a double serpentine arrangement, the coil inlet connections will be on one side and the outlet on the opposite side. (Refer to serpentine arrangements).
5. All technical information on this page is without manifolds and three-way valve arrangement. (refer to the section "Accessories, flow control purchase).
6. The units will be delivered in 3 different pieces: upper, middle and lower section.

Last update: 01/06/2023

HXI 42X-44X

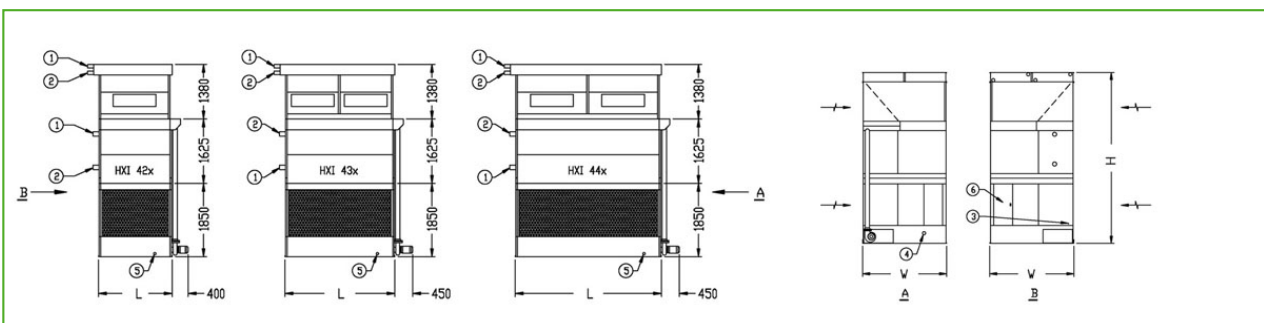

1. Inlet connection; 2. Outlet connection; 3. Make up ND15; 4. Overflow ND80; 5. Drain ND50; 6. Access door.



Model	Weights (kg)			Dimensions (mm)			Air Flow (m ³ /s)	Fan Motor (kW)	Water Flow (l/s)	Pump Motor (kW)	Inlet/Outlet Coil Connections (mm) Finned Coil
	Oper. Weight (kg)	Ship. Weight(kg)	Heaviest Section (kg)	L	W	H					
HXI 420-K	3810	2570	1110	1861	2385	4855	13.0	(1x) 7.5	12.0	(1x) 1.1	(2x) 80
HXI 421-K	4020	2710	1260	1861	2385	4855	12.9	(1x) 7.5	12.0	(1x) 1.1	(2x) 80
HXI 422-K	4230	2850	1400	1861	2385	4855	12.8	(1x) 7.5	12.0	(1x) 1.1	(2x) 80
HXI 430-L	5560	3700	1660	2775	2385	4855	20.2	(2x) 5.5	18.3	(1x) 2.2	(2x) 80
HXI 431-L	5870	3910	1870	2775	2385	4855	19.9	(2x) 5.5	18.3	(1x) 2.2	(2x) 80
HXI 432-L	6190	4130	2090	2775	2385	4855	19.6	(2x) 5.5	18.3	(1x) 2.2	(2x) 80
HXI 440-M	7011	4520	1960	3690	2385	4855	26.6	(2x) 7.5	31.5	(1x) 2.2	(2x) 80
HXI 441-M	7421	4800	2240	3690	2385	4855	26.3	(2x) 7.5	31.5	(1x) 2.2	(2x) 80
HXI 442-M	7851	5090	2530	3690	2385	4855	26.0	(2x) 7.5	31.5	(1x) 2.2	(2x) 80



HXI (Q)54X - (Q)56X

Closed circuit cooling towers

Engineering data

REMARK: Do not use for construction. Refer to factory certified dimensions & weights. This page includes data current at time of publication, which should be reconfirmed at the time of purchase. In the interest of product improvement, specifications, weights and dimensions are subject to change without notice.

General notes

1. Pipe sizes are nominal diameters. All connections have BSP male thread except for the 15 mm vent which has a female BSP thread.
2. Dimensional drawings show standard (right hand) arrangements with the standard finned coil arrangement. Left hand arrangement can be furnished by special order.
3. Coil connection locations are approximate. Dimensions should not be used for prefabrication of the connecting piping.
4. For high process flows, the double serpentine finned coil arrangement (HXI D) might be used. For a finned coil bundle with a double serpentine arrangement, the coil inlet connections will be on one side and the outlet on the opposite side. (Refer to serpentine arrangements).
5. All technical information on this page is without manifolds and three-way valve arrangement. (refer to the section "Accessories, flow control purchase).
6. The units will be delivered in 3 different pieces: upper, middle and lower section.

Last update: 01/06/2023

HXI (Q)54X - (Q)56X

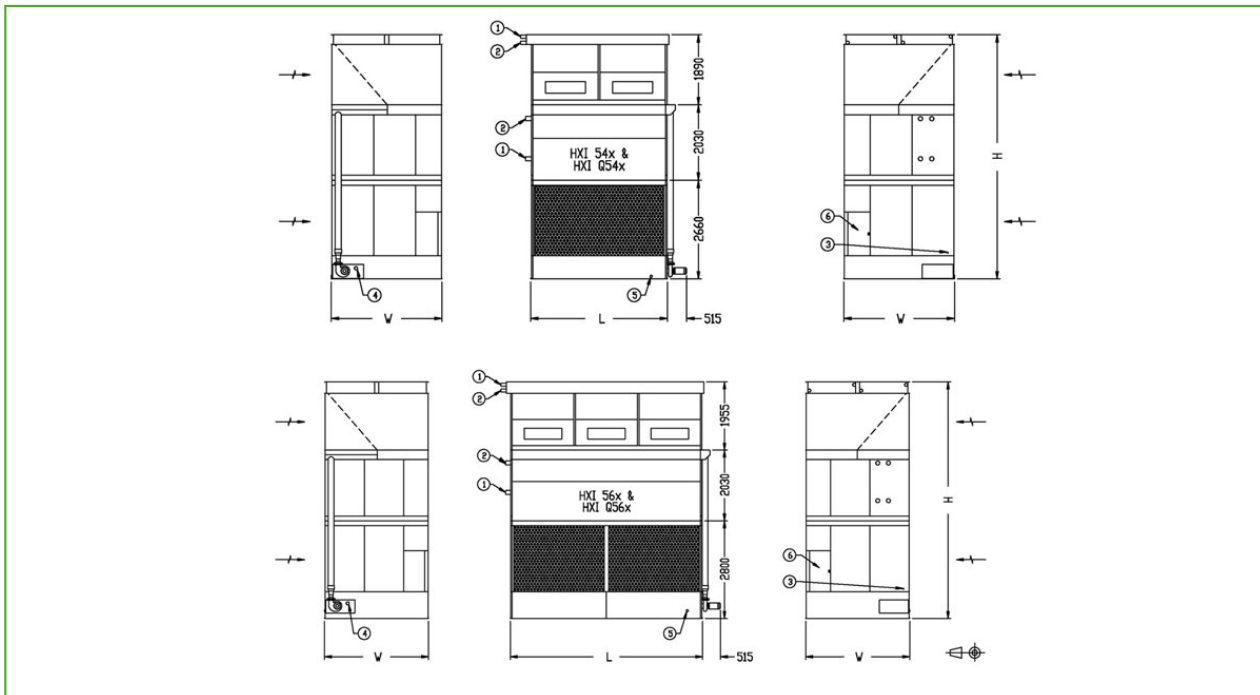

1. Inlet connection; 2. Outlet connection; 3. Make up ND25; 4. Overflow ND80; 5. Drain ND50; 6. Access door.



Model	Weights (kg)			Dimensions (mm)			Air Flow (m ³ /s)	Fan Motor (kW)	Water Flow (l/s)	Pump Motor (kW)	Inlet/Outlet Coil Connections (mm) Finned Coil
	Oper. Weight (kg)	Ship. Weight(kg)	Heaviest Section (kg)	L	W	H					
HXI 540-O	8691	5700	2400	3690	2985	6580	35.5	(2x) 11.0	45.1	(1x) 4.0	(2x) 80
HXI 541-O	9311	6140	2840	3690	2985	6580	35.1	(2x) 11.0	45.1	(1x) 4.0	(2x) 80
HXI 542-O	9931	6580	3280	3690	2985	6580	34.9	(2x) 11.0	45.1	(1x) 4.0	(2x) 80
HXI Q540-O	9931	6580	3280	3690	2985	6580	34.9	(2x) 11.0	45.1	(1x) 4.0	(2x) 80
HXI Q541-O	11181	7460	4160	3690	2985	6580	34.6	(2x) 11.0	45.1	(1x) 4.0	(2x) 80
HXI 560-O	12695	8220	3360	5520	2985	6785	53.6	(3x) 11.0	56.8	(1x) 5.5	(2x) 100
HXI 561-O	13635	8880	4090	5520	2985	6785	53.1	(3x) 11.0	56.8	(1x) 5.5	(2x) 100
HXI 562-O	14575	9540	4740	5520	2985	6785	52.7	(3x) 11.0	56.8	(1x) 5.5	(2x) 100
HXI Q560-O	14575	9540	4740	5520	2985	6785	52.7	(3x) 11.0	56.8	(1x) 5.5	(2x) 100
HXI Q561-O	16475	10880	6090	5520	2985	6785	52.3	(3x) 11.0	56.8	(1x) 5.5	(2x) 100



HXI (Q)64X - (Q)66X

Closed circuit cooling towers

Engineering data

REMARK: Do not use for construction. Refer to factory certified dimensions & weights. This page includes data current at time of publication, which should be reconfirmed at the time of purchase. In the interest of product improvement, specifications, weights and dimensions are subject to change without notice.

General notes

1. Pipe sizes are nominal diameters. All connections have BSP male thread except for the 15 mm vent which has a female BSP thread.
2. Dimensional drawings show standard (right hand) arrangements with the standard finned coil arrangement. Left hand arrangement can be furnished by special order.
3. Coil connection locations are approximate. Dimensions should not be used for prefabrication of the connecting piping.
4. For high process flows, the double serpentine finned coil arrangement (HXI D) might be used. For a finned coil bundle with a double serpentine arrangement, the coil inlet connections will be on one side and the outlet on the opposite side. (Refer to serpentine arrangements).
5. All technical information on this page is without manifolds and three-way valve arrangement. (refer to the section "Accessories, flow control purchase).
6. The units will be delivered in 3 different pieces: upper, middle and lower section.

Last update: 01/06/2023

HXI (Q)64X - (Q)66X

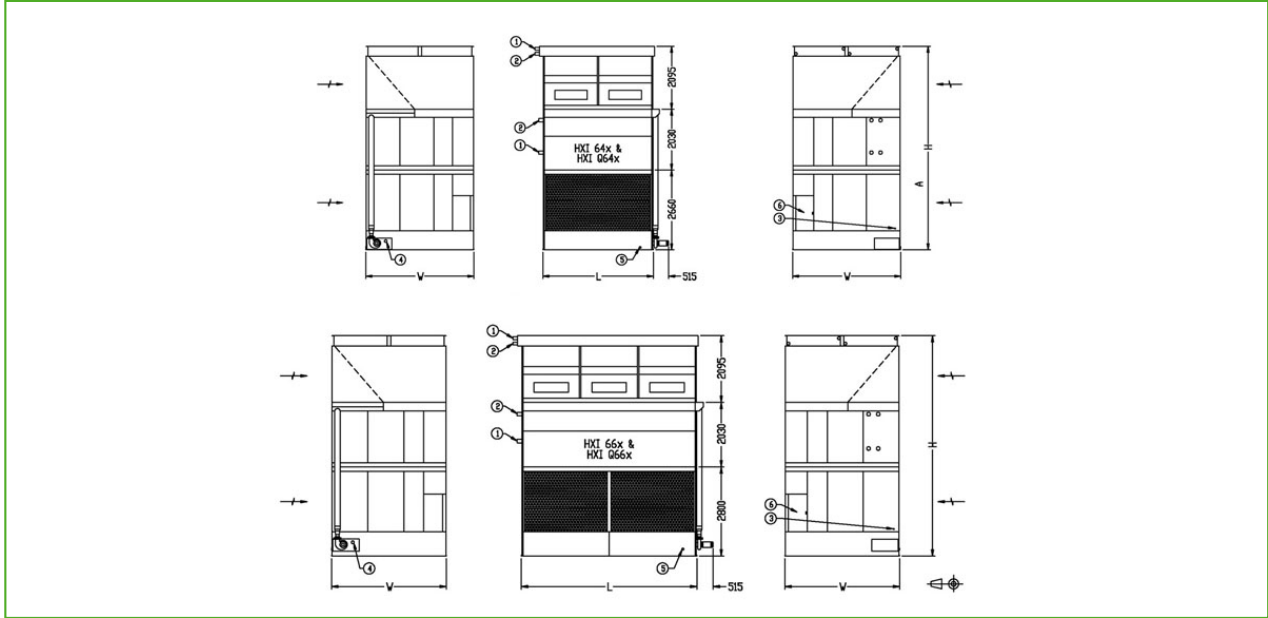

1. Inlet connection; 2. Outlet connection; 3. Make up ND25; 4. Overflow ND80; 5. Drain ND50; 6. Access door.



Model	Weights (kg)			Dimensions (mm)			Air Flow (m ³ /s)	Fan Motor (kW)	Water Flow (l/s)	Pump Motor (kW)	Inlet/Outlet Coil Connections (mm) Finned Coil
	Oper. Weight (kg)	Ship. Weight(kg)	Heaviest Section (kg)	L	W	H					
HXI 640-O	10050	6330	2575	3690	3610	6785	39.9	(2x) 11.0	45.1	(1x) 4.0	(2x) 100
HXI 641-O	10740	6810	3055	3690	3610	6785	39.2	(2x) 11.0	45.1	(1x) 4.0	(2x) 100
HXI 642-O	11430	7290	3535	3690	3610	6785	38.7	(2x) 11.0	45.1	(1x) 4.0	(2x) 100
HXI Q640-O	11430	7290	3540	3690	3610	6785	38.7	(2x) 11.0	45.1	(1x) 4.0	(2x) 100
HXI Q641-O	12790	8240	4480	3690	3610	6785	37.8	(2x) 11.0	45.1	(1x) 4.0	(2x) 100
HXI 660-O	14690	9085	3710	5520	3610	6925	60.5	(3x) 11.0	56.8	(1x) 5.5	(2x) 100
HXI 661-O	15700	9795	4420	5520	3610	6925	59.5	(3x) 11.0	56.8	(1x) 5.5	(2x) 100
HXI 662-O	16710	10505	5130	5520	3610	6925	58.6	(3x) 11.0	56.8	(1x) 5.5	(2x) 100
HXI Q660-O	16710	10505	3710	5520	3610	6925	60.5	(3x) 11.0	56.8	(1x) 5.5	(2x) 100
HXI Q661-O	18750	11955	6570	5520	3610	6925	57.4	(3x) 11.0	56.8	(1x) 5.5	(2x) 100

Sound attenuation

Closed circuit cooling towers

Engineering data

REMARK: Do not use for construction. Refer to factory certified dimensions & weights. This page includes data current at time of publication, which should be reconfirmed at the time of purchase. In the interest of product improvement, specifications, weights and dimensions are subject to change without notice.

General notes

1. Pipe sizes are nominal diameters. All connections have BSP male thread except for the 15 mm vent which has a female BSP thread.
2. Dimensional drawings show standard (right hand) arrangements with the standard finned coil arrangement. Left hand arrangement can be furnished by special order.
3. Coil connection locations are approximate. Dimensions should not be used for prefabrication of the connecting piping.
4. For high process flows, the double serpentine finned coil arrangement (HXI D) might be used. For a finned coil bundle with a double serpentine arrangement, the coil inlet connections will be on one side and the outlet on the opposite side. (Refer to serpentine arrangements).
5. All technical information on this page is without manifolds and three-way valve arrangement. (refer to the section "Accessories, flow control purchase).
6. The units will be delivered in 3 different pieces: upper, middle and lower section.

Last update: 01/06/2023

Sound attenuation

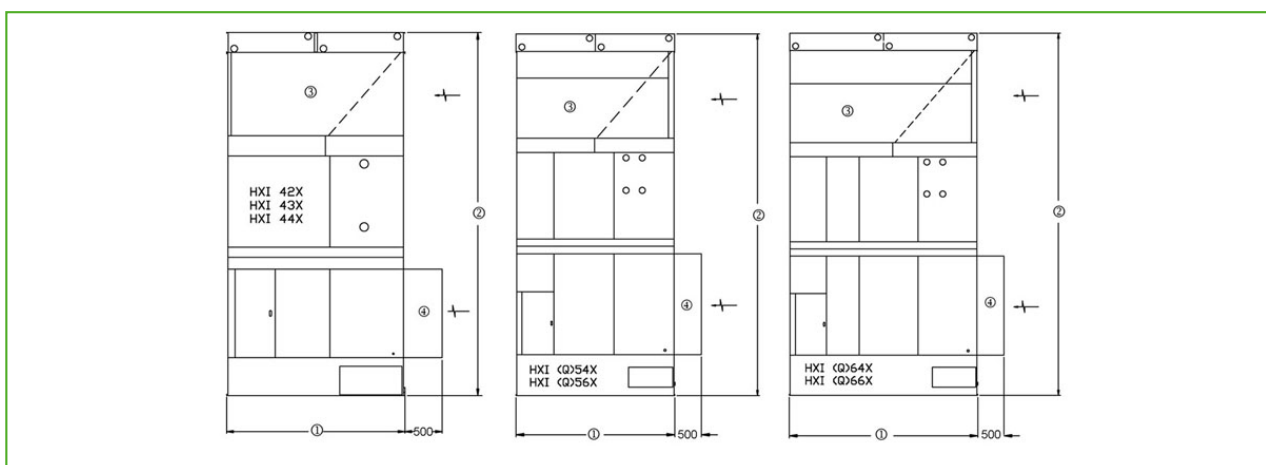

1. Unit Width; 2. Unit Height; 3. Insulated plenum; 4. Intake attenuator.



Model	Weight Sound Attenuator (kg)
HXI 420-K	100
HXI 421-K	100
HXI 422-K	100
HXI 430-L	130
HXI 431-L	130
HXI 432-L	130
HXI 440-M	175
HXI 441-M	175
HXI 442-M	175
HXI 540-O	250
HXI 541-O	250
HXI 542-O	250
HXI Q540-O	250
HXI Q541-O	250
HXI 560-O	375
HXI 561-O	375
HXI 562-O	375
HXI Q560-O	375
HXI Q561-O	375
HXI 640-O	250
HXI 641-O	250
HXI 642-O	250
HXI Q640-O	250
HXI Q641-O	250
HXI 660-O	375
HXI 661-O	375
HXI 662-O	375
HXI Q660-O	375
HXI Q661-O	375